

HEWLETT-PACKARD JOURNAL



Cover: RAPID, DIRECT MEASUREMENT OF COMPLEX
IMPEDANCE IN A CIRCUIT: see page 12
See Also: METHODS OF MEASURING IMPEDANCE: page 2

JANUARY 1967

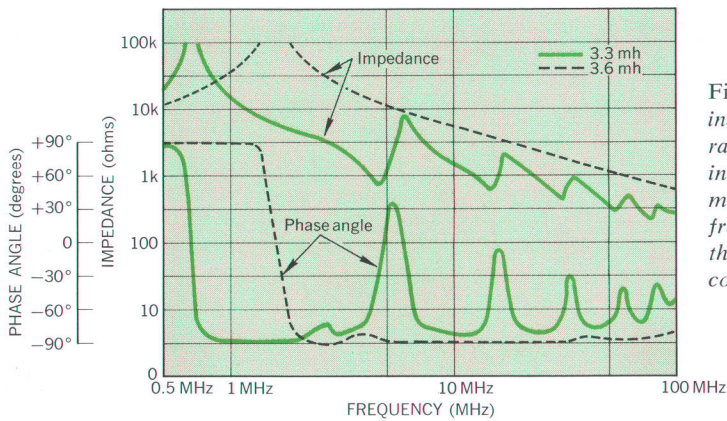

Fig. 1. Two chokes of nearly equal inductance behave differently over a range of frequencies due to differences in construction. Only impedance measurements over a wide range of frequencies will determine accurately the characteristics of circuit components.

Methods of Measuring Impedance

A review of some important systems for measuring the impedance of devices and circuits

IMPEDANCE IS THE SINGLE TERM that describes the relationship between voltage and current in a device or circuit. Since impedance is a complex quantity, it is represented as a vector. It can be measured in a number of ways. But however it is measured, impedance is a basic parameter in device and circuit design.

To design a circuit to perform in a desired way, it obviously is necessary to know the electrical characteristics of each circuit element. These electrical characteristics may vary in a complicated way with frequency, since at higher frequencies a single lumped element becomes a 'circuit' consisting of the basic element plus a number of parasitic elements. The magnitudes of these parasitics depend largely upon the construction of the device and are difficult or impossible to predict. Thus, the behavior of the two chokes of similar value, Fig. 1, differs considerably at higher frequencies. In a circuit, these impedances interact in an even more complicated fashion.

It is possible, to a certain extent, to predict circuit performance by calculation. However, theoretical calculations often disagree with actual measured values for a number of reasons including stray capacitance, lead inductance and unaccountable losses in coils and transformers. Therefore, the impedance of devices and circuits must be measured to realize a practical device from theoretical design.

Basic Concepts

Electronic circuit elements generally consist of combinations of resistance and reactance in a variety of con-

figurations. A perfect element which is ideally resistive or ideally reactive rarely exists. In practice the purely reactive device has resistance associated with it in some way and the 'purely' resistive device has reactance distributed in series with it and around it.

A capacitor can never be considered to be pure capacitance over an unlimited frequency range. It will have associated with it series resistance and shunt resistance. At some frequency the inductance of its very structure may be series resonant and the capacitor may appear as a pure resistance, Fig. 2(a). Beyond this frequency it will appear inductive.

A similar situation exists with inductors. The distributed capacitance of the windings is parallel resonant with the inductance at some frequency. Above this frequency the inductor appears capacitive, Fig. 2(b). Therefore in practical circuit design, it is necessary to characterize elements in terms of the amount of resistance and reactance present.

In speaking of impedance some form of complex notation is required to account for the simultaneous existence of reactance and resistance. Since the current that flows in a resistor is in phase with the applied voltage, it represents an absorber of real power ($P = IE$) and the resistor is considered the real part of the impedance. In the theoretical reactive element, ac current is in quadrature with the applied voltage, with the current in an inductor lagging the applied voltage by 90° . The result is that these elements never absorb power since power is actually $I \times E \times \text{Cos } \theta$, and $\text{Cos } 90^\circ = 0$. These elements only store energy and return it. Thus the reactive

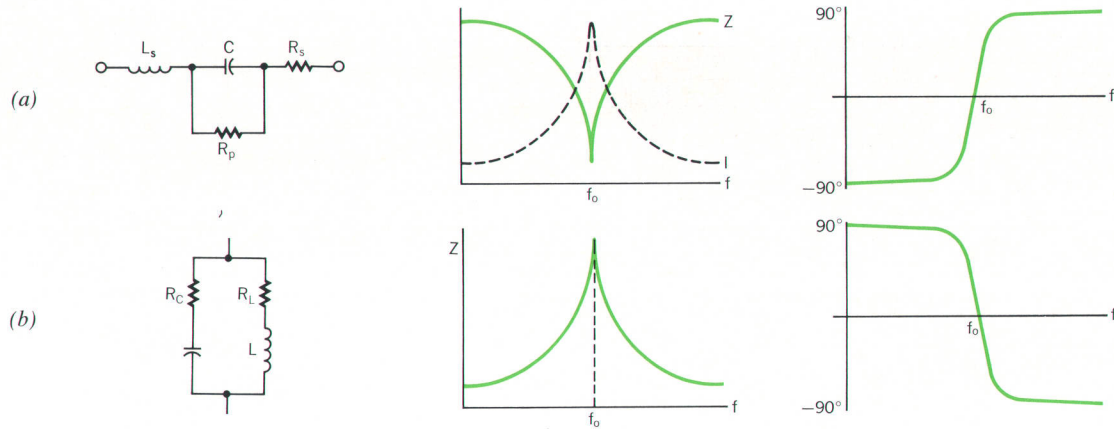
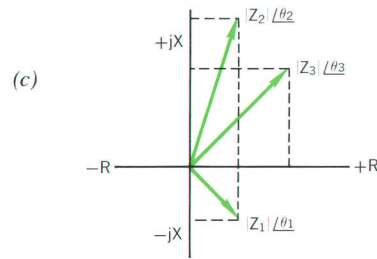

Fig. 2. Series resonant curves (a) show current peak and minimum impedance at resonance. Above resonance X_L becomes dominant and the phase angle is positive. In a parallel resonant circuit (b) at low frequencies, the inductive branch draws a large current which lags the applied voltage. At high frequencies, the capacitive branch draws a large current which leads the applied voltage. In the graphical representation of the impedance plane (c), Z_3 is the sum of vectors representing series impedances Z_1 and Z_2 .



part of the impedance is considered imaginary and has a j placed in front of it. Capacitive reactance is then equal to $\frac{-j}{2\pi fC}$ and inductive reactance is equal to $j2\pi fL$.

In the graphical representation of the impedance plane, Fig. 2(c), the horizontal axis is real, or resistive, and the vertical axis is imaginary, or reactive. Impedance can be represented by a point plotted in this plane and can be described in two ways: The length of the vector Z and its phase angle θ (Z/θ), is a complete description. However the sum of the two quadrature vectors $R \pm jX$ represents the same quantity in terms of the two elements which if placed in series will give an equivalent result.

As the term impedance is generally used to represent the complex ratio of E/I and is represented by a series combination of R and X , it is often convenient to work with the inverse ratio I/E which is called admittance and is represented by a parallel combination of a resistive component and a reactive component. To prevent confusion the parallel resistive component is called conductance and the parallel reactive component is called susceptance. They relate as follows:

$$\text{Impedance} = Z = \frac{E}{I} = R + jX$$

$$\text{Admittance} = Y = \frac{1}{Z} = \frac{1}{R + jX} = \frac{R}{R^2 + X^2} - j \frac{X}{R^2 + X^2} = G + jB$$

where G = conductance and B = susceptance. The re-

lation between series and parallel components can be shown with this conversion:

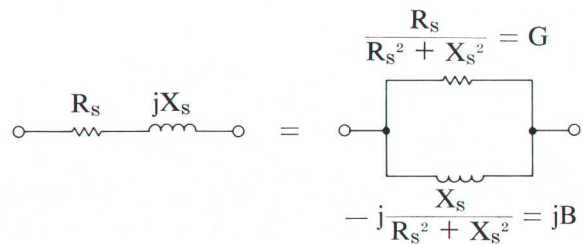

It is important to note that an inductive reactance has a positive sign while an inductive susceptance will have a negative sign because of the inversion. It is still inductive. Likewise a capacitive reactance will have a minus sign and a capacitive susceptance will have a plus sign. It may be now somewhat obvious that impedance is of use when placing elements in series and admittance is of value when placing elements in parallel. The very general term immittance is used to refer to the general relationship between I and E and refers to Z or Y interchangeably.

Since impedance is a property which describes the behavior of an element and its effect on a circuit, and because the elements that make up the total impedance are generally frequency dependent, the impedance will most likely vary as a function of frequency. X_L varies directly with frequency and X_C varies inversely with frequency, and incidental losses may vary in numerous

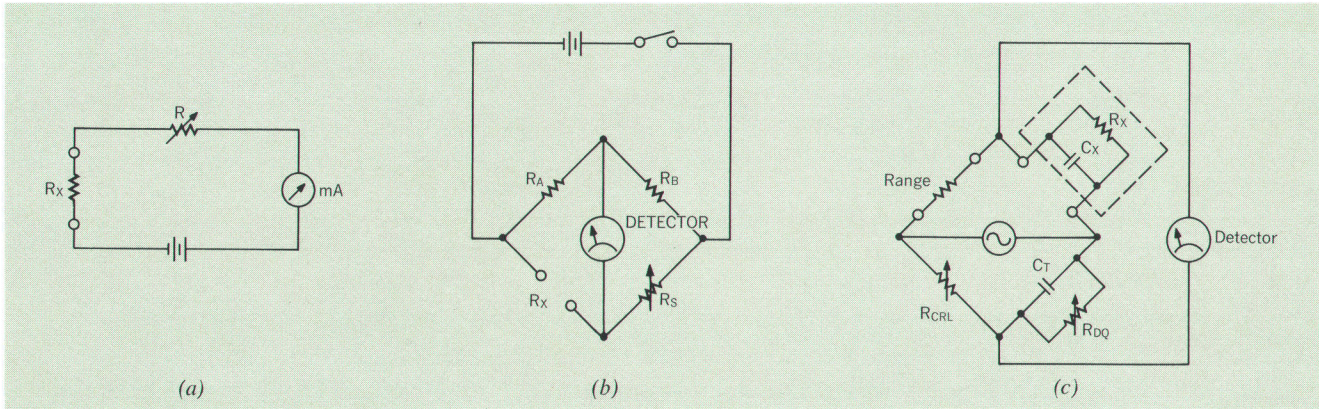

Fig. 3. The simple ohmmeter (a) for making dc resistance measurements is based on Ohm's Law. Variable resistor R is used to adjust the scale to zero when the R_x terminals are shorted. Basic Wheatstone bridge (b) in which arms R_A , R_B , and R_S are known. At balance, $R_x = R_S \frac{R_A}{R_B}$, thus comparing the unknown to the known resistances. Typical impedance bridge configuration (c). Here capacitor C_X is being measured. R_x is the capacitor loss factor. To achieve balance, R_{CRL} must be adjusted as well as R_{DQ} . R_{DQ} must be adjusted to match the time constant of the $C_T R_{DQ}$ arm to that of the $C_X R_x$ arm.

ways. Thus to determine the true nature of a circuit element, it is necessary to make impedance measurements at more than one frequency.

Impedance may be measured by several methods. Some are manual point-by-point methods that are difficult and time consuming. Other methods using specifically-designed instruments provide relatively simple and fast automatic measurements over a wide frequency range.

Resistance Measurements

If a circuit element is predominantly all resistive and is to be used in a network in which a minor reactive component is of no consequence over the frequency range of interest, it is possible to use a very simple measuring device which can only measure resistance. The ohmmeter, Fig. 3(a), is the simplest form of this type of instrument. It applies a known dc voltage to an unknown and measures the resulting current on a meter calibrated in ohms. Since the measurement is at dc or zero frequency, the concept of phase does not enter the measurement.

For more accurate resistance measurements, a Wheatstone bridge may be used, Fig. 3(b). This is a network of four resistors, three known and one unknown, so arranged that when they all are adjusted to certain values no transmission occurs from the generator to the detector. In other words, the voltage across the detector is zero when the bridge is balanced. Basically, the Wheatstone

bridge compares known elements to unknown elements. Accuracy of the measurement depends upon the accuracy of the known elements and the sensitivity of the null detector.

The Wheatstone bridge principle may be used at ac as well as dc. But it is necessary to have reactive elements in the other arms of the bridge to make the necessary phase correction to bring the network to balance or null, since any resistor may have a small reactive component which would shift the phase from zero as frequency increases.

Impedance Bridges

The impedance bridge in general may be any network of individual elements which has the property of zero transmission between the input and output terminals for a given unique combination of elements in the same manner as the resistance bridge. One of the branches of a typical impedance bridge, Fig. 3(c), is the unknown. The other branches may be variable and are calibrated to

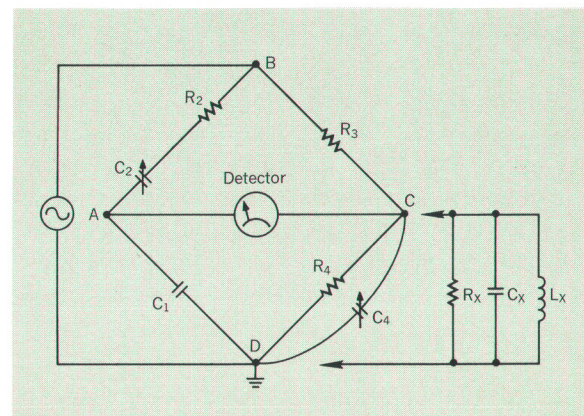

Fig. 4. Schering bridge circuit which maintains a constant relationship between bridge elements regardless of frequency. Both the variable bridge elements can be air capacitors which are superior to other types of variable impedances.

facilitate measurement. Again, this bridge is a comparison technique. The measurement is made with reference to other elements of the bridge which have been previously measured or calibrated. While comparison can be made with great precision if the null detector is very sensitive, the accuracy is no better than the calibrated elements.

A modified impedance bridge useful over a wide range of frequencies is the Schering bridge, Fig. 4. The generator output is applied to the terminals B-P and the detector is between terminals A-C. The conditions for zero transmission are simply that

$$Z_{AB} Z_{CD} = Z_{AD} Z_{BC} \text{ at balance,}$$

or

$$\left(R_2 + \frac{1}{j\omega C_2} \right) \left(\frac{1}{\frac{1}{R_4} + j\omega C_4} \right) = \frac{R_3}{j\omega C_1}$$

$$R_2 + \frac{1}{j\omega C_2} = \frac{R_3}{j\omega C_1} \left(\frac{1}{R_4} + j\omega C_4 \right)$$

$$= \frac{R_3}{j\omega C_1 R_4} + \frac{C_4 R_3}{C_1}$$

Equating reals

$$R_2 = \frac{C_4 R_3}{C_1}, \text{ and } \frac{R_2}{C_4} = \frac{R_3}{C_1}$$

Equating imaginaries

$$\frac{1}{j\omega C_2} = \frac{R_3}{j\omega C_1 R_4}$$

$$\frac{R_3}{C_1} = \frac{R_4}{C_2}$$

Therefore:

$$\frac{R_2}{C_4} = \frac{R_3}{C_1} = \frac{R_4}{C_2}$$

The Schering bridge is particularly useful for several reasons. First the conditions for balance do not involve frequency. Therefore, if the bridge is balanced at one frequency it will remain balanced at other frequencies. Another significant point is that a capacitor in one arm is related to a resistor in another arm. This implies that a change in resistance R_4 in branch CD for example, will be counteracted by a change in C_2 in branch AB. The result is that the bridge can be brought to balance by varying only capacitors. As a practical matter it is easier to make and calibrate good variable capacitors over a wide frequency range than it is to make variable resistance elements.

One of the disadvantages of bridges of this general form is the lack of a common terminal between the generator and the detector. Therefore, a transformer is generally used to isolate either the input or the output

from ground. But the transformer may be a source of error due to practical limits in its design. This problem has been solved with the use of the twin-T network (see Fig. 5). The circuit has a common terminal in the center and requires no transformer.

While the twin-T arrangement is often used at higher frequencies where transformers are awkward and might contribute large unknown errors, it has one shortcoming. Its conditions for balance are frequency dependent. The conditions for zero transmission or null from Fig. 5(a), are given by

$$Z_1 + Z_3 + \frac{Z_1 Z_3}{Z_2} + Z'_1 + Z'_3 + \frac{Z'_1 Z'_3}{Z'_2} = 0$$

Inductances are needed only for balance and do not enter into the calibration of the bridge. From the balance equation, Fig. 5(b), it can be seen that the condition of balance involves frequency. If the bridge is balanced at one frequency, it is not necessarily balanced at any other. Therefore it may not be as convenient to use as some other forms.

A number of useful variations on this scheme have provided means for calibrating the errors out of the system. One method employed at the National Bureau

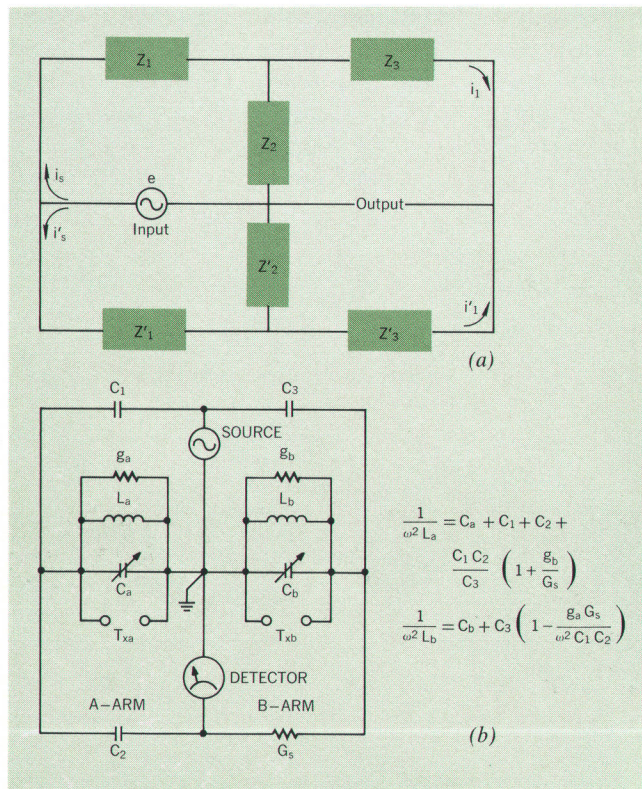

Fig. 5. General form of the twin-T bridge (a) and a simplified form of a practical bridge (b). From the balance equations, it is obvious that the condition for balance is frequency dependent.

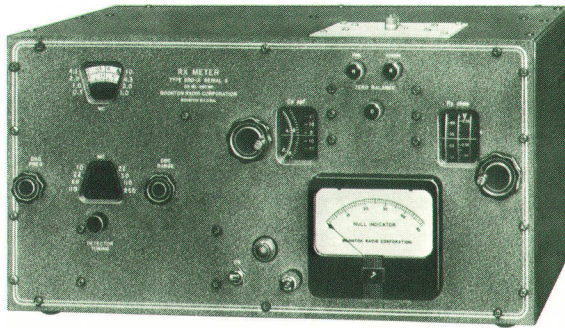

Fig. 6. The -hp- Model 250 RX Meter which is especially useful for measurement of very low Q .

of Standards measures the resistive component of impedances in terms of capacitance variation only and does not require accurate knowledge of the absolute values of the standards used.¹

Bridge Systems

Of course, the bridges mentioned previously are just part of a measuring system. It is exceedingly important to have a stable well-shielded source of power to drive the bridge and a sensitive, quiet and well-shielded detector to indicate when the no-transmission or null condition is met. The well-shielded aspect cannot be overstressed because transmission from source to detector through other paths can result in balances which are in error due to an unwanted path. In using an unshielded bridge, a balance might be obtained but in fact, might be offset by 30% or more from the correct value.

¹ 'A Self-Calibrating Instrument for Measuring Conductance at Radio Frequencies, Leslie E. Huntley, National Bureau of Standards Journal of Research, Vol. 69C, No. 2, April, 1965, pp. 115-126.

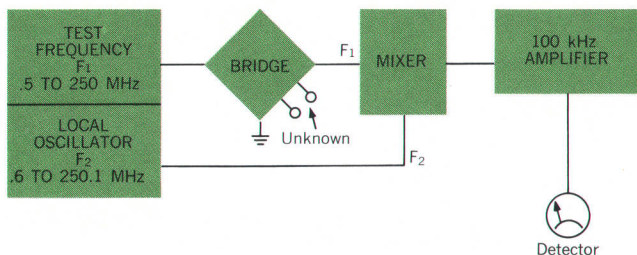

Fig. 7. Basic circuit of the -hp- Model 250A RX Meter is essentially a refined Schering bridge with an oscillator, detector, amplifier, null detector and power supply. When the bridge circuit is balanced in both amplitude and phase, no 100 kHz signal is produced.

RX Meter

A typical bridge system, the -hp- Model 250A RX Meter (Fig. 6), employs the Schering bridge in conjunction with a superheterodyne detector, and a well-shielded oscillator (Fig. 7). The local oscillator for the superheterodyne detector is mechanically linked to the driving oscillator and roughly tracked to it so that only small tuning adjustments are required to peak the detector. Compressing the meter presentation by AGC action in the IF amplifier results in a null detector that is very sensitive near null but can handle more than 60 dB signal range without going off scale. Sometimes when the indicator of a bridge that has a large transmission from in to out is off balance and the indicator is off scale, it is difficult to immediately determine which way to turn the controls to restore balance. Automatically reducing sensitivity off null helps avoid this problem.

A system such as this is extremely useful for impedance measurement between 500 kHz and 250 MHz. It reads in units of parallel resistance and capacitance, largely because the $R_4 C_4$ arm is convenient to use as the unknown terminal. C_4 is then calibrated in terms of resistance added or removed in parallel with R_4 . Because of the extremely good null sensitivity it is possible to read very small capacitances in parallel with resistors or indirectly measure a very small inductive component in series with a resistor, that is, where the phase angle is very near zero.

A bridge of this type can also indicate large resistive components in parallel with small reactances where the phase angle approaches $\pm 90^\circ$. But losses in the binding posts and associated circuitry tend to spoil the accuracy to some degree when the ratio of R to X exceeds 100. In addition, the parallel resistance resolution is at its extreme limit at 100,000 ohms.

Semiautomatic Bridges

The typical universal impedance bridge, Fig. 3(c), requires the adjustment of two interdependent variables to achieve a null. Besides the adjustment of R_{CRL} , the R_{DQ} control must be adjusted to match the RC time constant in the unknown leg of the bridge. The number of nulling operations increase with the amount of interaction between R_{CRL} and R_{DQ} .

Several methods for achieving a bridge balance with a minimum of adjustments have been developed. One of the more sophisticated methods, used in the bridge, Fig. 8, provides for automatic control of the DQ resistor. In the automatic mode, Fig. 9, the variable resistance controlled by the DQ dial is replaced by series-connected diodes. The ac resistance of the diodes can be varied by changing the dc current through them.

The diode current is derived from the output of a phase detector which responds to the bridge unbalance voltage. The diode resistance is electronically adjusted to

maintain the proper phase relationship between the bridge output voltage and the reference. Only the CRL control is needed to bring the bridge into balance, since the diode resistance automatically tracks the CRL control. The bridge may then be switched to the manual mode and the value of D and Q determined with the DQ control.

Although this universal impedance bridge eliminates many adjustments, it measures impedance at only one frequency, namely 1 kHz. Thus its use is limited to measurements of capacitance and inductance at that frequency, although with this specific instrument, an external oscillator and null detector may be used to extend the frequency range somewhat, but without the semi-automatic feature.

Q Meter

The familiar symbol Q is defined in a circuit at resonance in terms of the ratio of total energy stored to the average power dissipated per cycle ($Q = \frac{\omega E}{W}$). For elements in series, Q is equal to the ratio of the reactance to the series resistance, or the ratio of susceptance to conductance in a parallel circuit. In one respect, Q may be considered as a figure of merit in terms of the ability of a circuit component to store energy compared to the energy it wastes. For a reactive component

$$Q = \frac{X_s}{R_s} = \frac{R_p}{X_p} = \tan \theta$$

where X_s and X_p are series and parallel impedance respectively, and R_s and R_p are series and parallel resistance. The magnitude of Q is significant as a measure of rf resistance of components, loss angle of capacitors, dielectric constants, antenna characteristics and transmission line parameters.

For circuit elements whose ratio of reactance to resistance is very high, it is better to measure the ratio Q rather than attempting to measure the minor component alone or the phase angle. Because the tangent function increases rapidly as the phase angle approaches 90 degrees, a small reading error results in a large measurement error. The Q meter, Fig. 10, measures the tangent directly.

The most common form of Q meter uses the series resonant circuit to determine the Q, Fig. 11. A small voltage ($E_{injected}$) is inserted in series with an inductor and a capacitor in series. The capacitor used is a very low loss air capacitor and is assumed to be lossless (a small source of error).

A voltmeter is placed across the capacitor. This voltmeter must have a very high impedance so that it does not load the circuit. The inductor whose Q is to be measured is assumed to be a series combination of L and R. When the variable air capacitor is adjusted such that

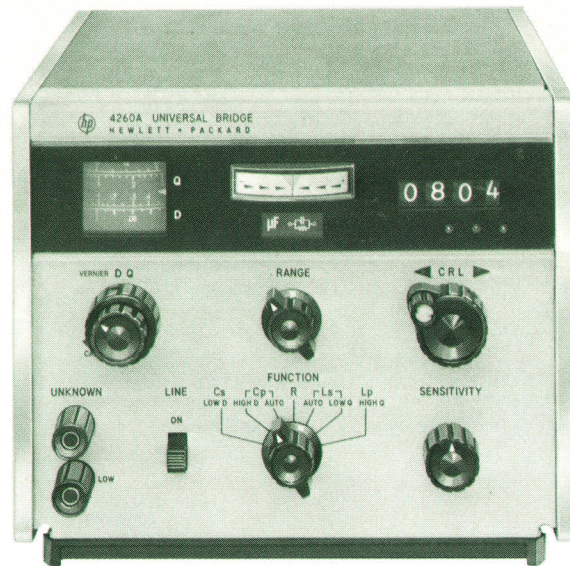

Fig. 8. This semiautomatic bridge, -hp- Model 4260A Universal Bridge, requires only one balancing control which simplifies measurement of resistance, capacitance, inductance, Q and loss factor.

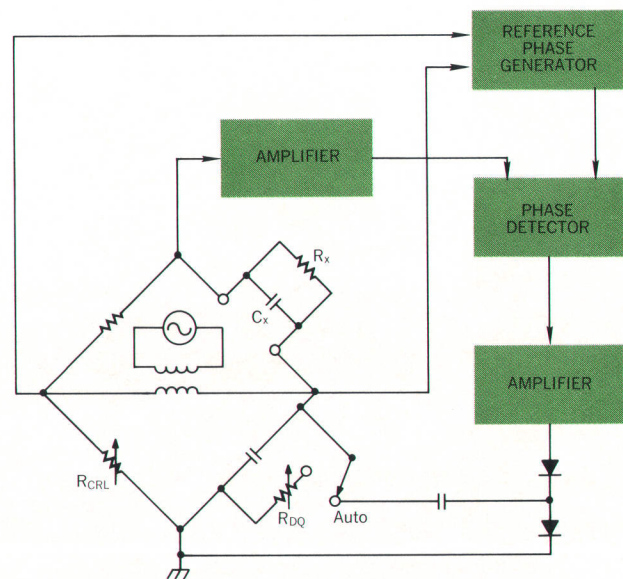

Fig. 9. The value of the R_{DQ} resistor is controlled automatically by a phase detector which responds to the phase relationship between the bridge output and a reference phase. This feedback method adjusts one bridge element automatically.

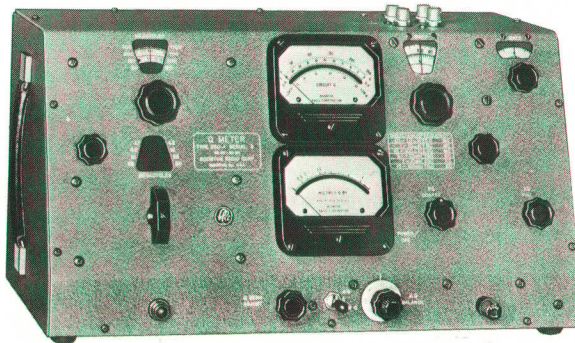

Fig. 10. Especially designed to measure Q , the -hp- Model 260A Q Meter measures Q of inductors from 10 to 625 directly over a frequency range from 50 kHz to 50 MHz.

$X_C = X_L$ the only remaining impedance in the loop is R since X_C and X_L are of opposite sign and cancel. The current which then flows is

$$\frac{E_{\text{injected}}}{R}$$

If we consider that the current flows through C , the voltage across C is

$$\frac{X_C \times E_{\text{inj.}}}{R_s}$$

But we said that $X_C/R_s = Q$. Replacing X_C/R_s with Q we get

$$Q \times E_{\text{inj}} = \text{the voltage across } C, \text{ or } Q = \frac{E_{\text{out}}}{E_{\text{in}}}$$

The Q meter therefore is set up to measure the ratio of reactance to resistance merely by reading a voltage ratio.

Some Basic Formulas Involving Q

Two-Terminal Impedance

Formulas Relating Series and Parallel Components

$$Q = \frac{X_s}{R_s} = \frac{\omega L_s}{R_s} = \frac{1}{\omega C_s R_s} = \frac{R_p}{X_p} = \frac{R_p}{\omega L_p} = R_p \omega C_p = \frac{\sqrt{L/C}}{R_s} = \frac{R_p}{\sqrt{L/C}}$$

General Formulas	Formulas for Q greater than 10	Formulas for Q less than 0.1	General Formulas	Formulas for Q greater than 10	Formulas for Q less than 0.1
$R_s = \frac{R_p}{1 + Q^2}$	$R_s \approx \frac{R_p}{Q^2}$	$R_s \approx R_p$	$R_p = R_s (1 + Q^2)$	$R_p \approx R_s Q^2$	$R_p \approx R_s$
$X_s = X_p \frac{Q^2}{1 + Q^2}$	$X_s \approx X_p$	$X_s \approx X_p Q^2$	$X_p = X_s \frac{1 + Q^2}{Q^2}$	$X_p \approx X_s$	$X_p \approx \frac{X_s}{Q^2}$
$L_s = L_p \frac{Q^2}{1 + Q^2}$	$L_s \approx L_p$	$L_s \approx L_p Q^2$	$L_p = L_s \frac{1 + Q^2}{Q^2}$	$L_p \approx L_s$	$L_p \approx \frac{L_s}{Q^2}$
$C_s = C_p \frac{1 + Q^2}{Q^2}$	$C_s \approx C_p$	$C_s \approx \frac{C_p}{Q^2}$	$C_p = C_s \frac{Q^2}{1 + Q^2}$	$C_p \approx C_s$	$C_p \approx C_s Q^2$

Tuned Circuit

1. Selectivity

$$Q = \frac{f_0}{f_1 - f_2} = \frac{2C_0}{C_2 - C_1}$$

Where f_1 and f_2 are half-power points and C_0 , C_1 , and C_2 are capacitance values at f_0 , f_2 and f_1 respectively.

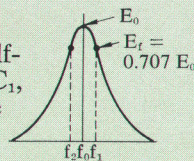

2. Resonant Rise in

$$\text{Voltage } Q = \frac{E}{e}$$

For relatively large R_s (low Q), $E = e\sqrt{1 + Q^2}$

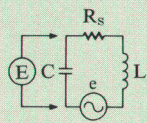

3. Power Dissipation

a. Power Factor = $\cos \phi$

$$= \frac{R}{\sqrt{R^2 + L^2 \omega^2}} = \frac{1}{\sqrt{1 + Q^2}}$$

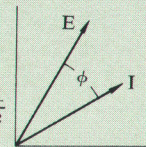

b. Damped Oscillations

$Q = \frac{\pi}{\delta}$, where δ is the logarithmic decrement.

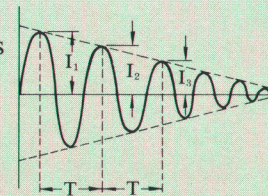

By calibrating the value of the resonating capacitor inductance can be measured by noting the frequency used and the value of the resonating capacitor. To avoid calculation, most Q meters have an L scale superimposed on the C dial and have a chart of specified frequencies at which the dial can be read directly with a suitable multiplier. The Q meter is an example of the use of an indirect measurement of a quantity which is not an impedance to achieve a measurement of impedance which would be difficult to make directly.

Direct Reading Impedance Meters

Vector impedance meters, Fig. 12, are examples of a new direct-reading class of truly automatic impedance measuring instruments.¹ There is no indirect representation or reference to another impedance standard. Voltage applied to a component is measured along with the current which flows as a result of the voltage. Then the ratio is calculated automatically. In addition vector impedance meters measure the phase relationship between the current and the voltage and read it out as the phase in terms of Z/θ . These instruments are of tremendous importance in measuring the vast middle ground of impedances where phase angle is between 5° and 85° . In this area there is no more than 10 to 1 ratio between the two components of X and R. The minor component error increases beyond this point because of absolute limits on phase resolution.

However, the vector impedance meters measure the major component of impedance with no decrease in accuracy as the phase angle approaches 90 degrees or zero degrees, that is, they are not affected by the Q of the impedance being measured. It is not possible to measure the minor component of the impedance directly.

In the measurement of minor components, the Q meter becomes accurate just where the vector impedance meter becomes inaccurate, that is, where the phase angle is more than 85° . At the other end where the phase angle is less than 5° , bridges such as the RX Meter are necessary.

Impedance Measurement at High Frequencies

Impedance is often measured in other, somewhat indirect methods as the frequency increases into the UHF region because impedance standards may not be available and direct measurement of current and voltage may be costly or nearly impossible. The most commonly used standard of impedance at the higher frequencies is the transmission line or waveguide with a characteristic impedance (Z_0) which is directly calculable from physical dimensions. The transmission line is a device which can be considered as possessing continuously distributed L

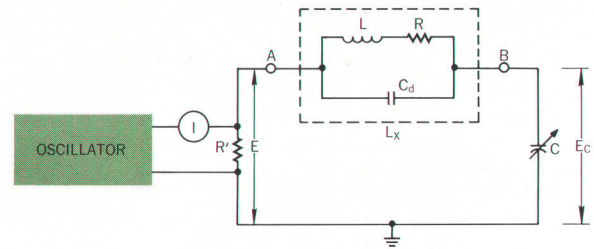
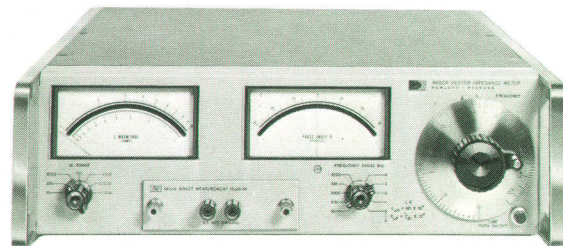
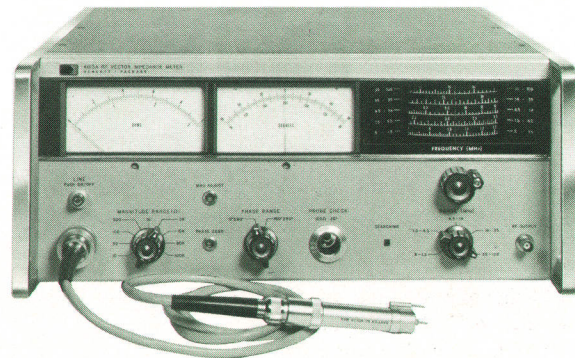

Fig. 11. In the Q meter, a known current I is passed through resistance R' which introduces the voltage E in series with the unknown L_x . The circuit under test is tuned to resonance with the oscillator frequency, and the voltage E_c is read. Then $Q = \frac{E_c}{E}$. In a series resonant circuit, the voltage appearing across either reactance is equal to the voltage induced in the circuit multiplied by the circuit Q .



(a)



(b)

Fig. 12. Passive components and networks can be measured directly and automatically when attached to the front-panel terminals of the -hp- Model 4800A Vector Impedance Meter (a). In-circuit measurements of both active and passive components may be made using the probe of the -hp- Model 4815A RF Vector Impedance Meter (b). The RF instrument covers the frequency range from 500 kHz to 108 MHz, while the Model 4800A covers the lower ranges from 5 Hz to 500 kHz.

¹ A detailed discussion of two new vector impedance meters and their applications is in the article starting on page 12 of this issue.

Comparison of Some Impedance Measuring Systems

INSTRUMENT	USE
Vector Impedance Meter 4800A	Fast automatic impedance readings, 5 Hz–½ MHz.
RF Vector Impedance Meter 4815A	Fast automatic impedance readings, ½ MHz–108 MHz.
Universal Bridge 4260A	Semiautomatic impedance measurement, 1 kHz.
RX Meter 250A	Manual two knob bridge measurement of impedance, high resolution, 0.5–250 MHz.
Q Meter 260A	Manual measurement of high Q coils, capacitors and large resistors, 50 kHz–50 MHz.
Q Meter 190A	Manual measurement of high Q coils, capacitors and large resistors, 20 MHz–270 MHz.
Vector Voltmeter 8405A with Directional Couplers	Fast automatic measurement of complex reflection coefficient, 100 MHz–1 GHz*.
Slotted Line	Manual measurement VSWR, 500 MHz–4000 MHz.
Time Domain Reflectometry	Fast determination of reflection coefficient in presence of multiple reflections, relationship to frequency indirect.

* Limited to frequency range of directional couplers.

and C in such a way that any point along the length of this line the ratio of V/I of a wave traveling in one direction is constant and equal to Z_0 . The method of comparison involves terminating the standard line with the component to be measured and observing one of several effects.

The immediate effect is one of reflection. Should the line be terminated with a component whose magnitude and phase angle is the same as the line impedance (Z_0),

no reflection will occur since the V/I ratio in the load matches the wave impedance. Should the V/I ratio in the load not match that in the incident wave as determined by Z_0 , the residue is reflected and becomes a wave traveling away from the load. If a device is available which could measure the voltage of the wave traveling in only one direction at a time, the ratio of the reflected voltage to the incident voltage could be determined. This ratio $\left(\frac{V_r}{V_i}\right)$ is known as the reflection coefficient (Γ).

One device which will make this measurement is the directional coupler. It couples to a wave going in one direction only. Two directional couplers connected in opposite directions will separate the required information.

To make a meaningful measurement of Z, phase angle information is also required. This can be obtained easily if a voltage measuring system (such as the *hp*- Model 8405A Vector Voltmeter) is capable of phase angle measurement.

An older method, the slotted section has been used for reflection measurements. This is a line or guide with a slot along its length which permits a small monitoring probe to be inserted and moved along the line, measuring the relative voltage at various points along the line. When a reflected wave moves back down a line toward the source there will be places where the incident and reflected waves are in phase and add. There will also be places where they are out of phase and subtract.

Charles G. Gorss



Charlie Gorss graduated from Cornell University with the degree of BEE in 1950. He joined the Boonton Radio Company, now the Hewlett-Packard Rockaway Division, in that year. He has been product designer on the Model 250A RX Meter and was project leader on the Model 225A Signal Generator, the AN-ARM-24 UHF Signal Generator, and the Model 280A UHF Q Meter. Presently he is group leader for impedance instruments.

Charlie is attending Stevens Institute of Technology working on his MEE. He is a member of IEEE, Tau Beta Pi and Eta Kappa Nu.

The ratio between maximum and minimum is a function of the two wave amplitudes. In the case of total reflection, complete cancellation can occur and the ratio approaches infinity. If there is no reflection the ratio is unity or no change. That gives rise to the term VSWR, or voltage standing wave ratio which relates Γ and Z in the following manner:

$$\Gamma = \frac{Z_L - Z_0}{Z_L + Z_0} = \frac{\text{VSWR} - 1}{\text{VSWR} + 1} = \frac{V_r}{V_i}$$

The position of the maximum and minimum pattern are a function of the phase of the reflection coefficient and now can be used to calculate Z_L . The phase is generally referenced by placing a short circuit at the terminals since this is a good standard of complete reflection and has a known 180° phase reversal. By knowing the location of the peaks and valleys on the slotted line with a short circuit at the terminals there is enough information to determine the nature of the unknown impedance.

Another expression which relates to impedance is return loss. This is again a measure of reflection. Should there be a short circuit on a line the reflection is complete and the signal is returned to the generator without loss. A perfect load on the other hand has infinite return loss. This is expressed in log form and relates to reflection coefficient as follows:

$$\text{Return loss} = -20 \log_{10} |\Gamma| \text{ decibels.}$$

It is a convenient unit to use if an attenuator is to be used as a standard of Z . An attenuator having a known attenuation factor when terminated by a perfect reflection has a return loss of two times the attenuation of the attenuator in dB since the signal goes through the attenuator twice. The attenuator must of course be bilateral. When used in series with a phase shifter, it can produce a wide range of impedances predictably. This type of standard could be used with a bridge network to measure an unknown device by comparison. There have been a number of such bridge structures constructed for this purpose.

Another type of reflection measuring device is the Time Domain Reflectometer. By means of modern high speed sampling oscilloscopes it is possible to apply a unit step to the input of a transmission line and observe the magnitude and nature of reflections at the end of, and along a transmission line. By using an oscilloscope, the returning reflections are strung out along the time base depending upon the length of time it takes for the impulse to travel to the reflection and return. Often in a high frequency system there are multiple reflections along a line at connectors etc. which create errors. However with a system which separates the reflections in time, the position of the principal reflection identifies it and the others may be ignored.

—Charles G. Gorss

Bibliography

- 'The Nature of Q,' BRC Notebook, No. 1, Spring, 1954.
- 'A Wide Range VHF Z Meter,' BRC Notebook, No. 2, Summer, 1954.
- 'A Versatile Instrument — The Q Meter,' BRC Notebook, No. 4, Winter, 1955.
- 'Some VHF Bridge Applications,' BRC Notebook, No. 6, Summer, 1955.
- 'Circuit Effects on Q,' BRC Notebook, No. 8, Winter, 1956.
- 'Q Meter Techniques,' BRC Notebook, No. 13, Spring, 1957.
- 'The RX Meter or the Q Meter?,' BRC Notebook, No. 16, Winter, 1958.
- 'Technical Contributions of the BRC Notebook,' BRC Notebook, No. 23, Winter, 1961.
- 'Design of a UHF Q Meter,' BRC Notebook, No. 27, Winter, 1961.
- 'Calibration of a UHF Q Meter,' BRC Notebook, No. 29, Summer, 1961.
- W. B. Wholey, 'Greater Reliability in UHF Impedance Measurements,' 'Hewlett-Packard Journal,' Vol. 1, No. 5, Jan., 1950.
- Arthur Fong, 'Direct Measurement of Impedance in the 50–500 MC Range,' 'Hewlett-Packard Journal,' Vol. 1, No. 8, April, 1950.
- W. B. Wholey, 'Good Practice in Slotted Line Measurements,' (Part I), 'Hewlett-Packard Journal,' Vol. 3, No. 1, Sept., 1951.
- W. B. Wholey, 'Good Practice in Slotted Line Measurements,' (Conclusion), 'Hewlett-Packard Journal,' Vol. 3, No. 2, Oct., 1951.
- 'A Novel Impedance-Measuring System Using Standard $-hp-$ Instruments,' 'Hewlett-Packard Journal,' Vol. 3, No. 11, July, 1952.
- J. K. Hunton and N. L. Pappas, 'The $-hp-$ Microwave Reflectometers,' 'Hewlett-Packard Journal,' Vol. 6, No. 1-2, Sept.-Oct., 1954.
- J. K. Hunton, H. C. Poulter and C. S. Reis, 'High-Directivity Coaxial Directional Couplers and Reflectometers,' 'Hewlett-Packard Journal,' Vol. 7, No. 2, Oct., 1955.
- J. K. Hunton and Elmer Lorence, 'Improved Sweep Frequency Techniques for Broadband Microwave Testing,' 'Hewlett-Packard Journal,' Vol. 12, No. 4, Dec., 1960.
- B. M. Oliver, 'Time Domain Reflectometry,' 'Hewlett-Packard Journal,' Vol. 15, No. 6, Feb., 1964.
- Robert Prickett, 'New Coaxial Couplers for Reflectometers, Detection, and Monitoring,' 'Hewlett-Packard Journal,' Feb., 1965.
- Katsumi Yoshimoto, 'A New Universal Impedance Bridge with Simplified, Semi-Automatic Tuning,' 'Hewlett-Packard Journal,' Vol. 18, No. 1, Aug., 1966.
- D. Woods, 'A Precision Dual Bridge for the Standardization of Admittance at very High Frequencies,' Part C of the Proceedings of the Institution of Electrical Engineers, Monograph No. 244R, June, 1957.
- R. N. Jones, R. E. Nelson, National Bureau of Standards, Boulder, Colorado, 'The Role of Capacitance in Natural Reference Standards for High-Frequency Impedance,' Proceedings Instrument Society of America, Vol. 17, Part 1, October, 1962.

Direct-Reading, Fully-Automatic Vector Impedance Meters

Two new instruments designed to measure impedance magnitude and phase angle quickly and easily over a broad frequency range

ENGINEERS FACED WITH THE PROBLEM of determining component or circuit impedance over a wide range of frequencies have had to accept tedious balancing adjustments and point plotting associated with most bridge techniques. When the results are finally obtained, they are valid for the components as attached to the terminals of the instrument, that is, detached from their working circuit.

In critical applications where it is necessary to determine impedance at a particular point in a circuit, the engineer resorts to a series of calculations based upon his individual impedance measurements. Added to the tedious measurement process, these calculations still leave an important unknown — the effect of stray capacitance, lead inductance and other interactions within the circuit.

Two new instruments have been designed to read impedance directly over a wide frequency range. Called Vector Impedance Meters, they are extremely valuable as circuit design tools. Both are fully automatic, requiring no nulling or balancing.

Impedance magnitude and phase angle are read out on front panel meters. Continuous plots of impedance versus frequency and phase angle versus frequency may be easily made by merely adjusting the frequency dial

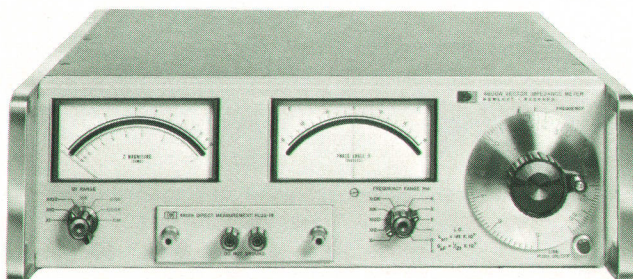

Fig. 1. This low-frequency -hp- Model 4800A Vector Impedance Meter makes rapid measurements of components and circuits with direct read-out over the frequency range from 5 Hz to 500 kHz, and over the impedance range from 10 ohms full scale to 10 megohms full scale.

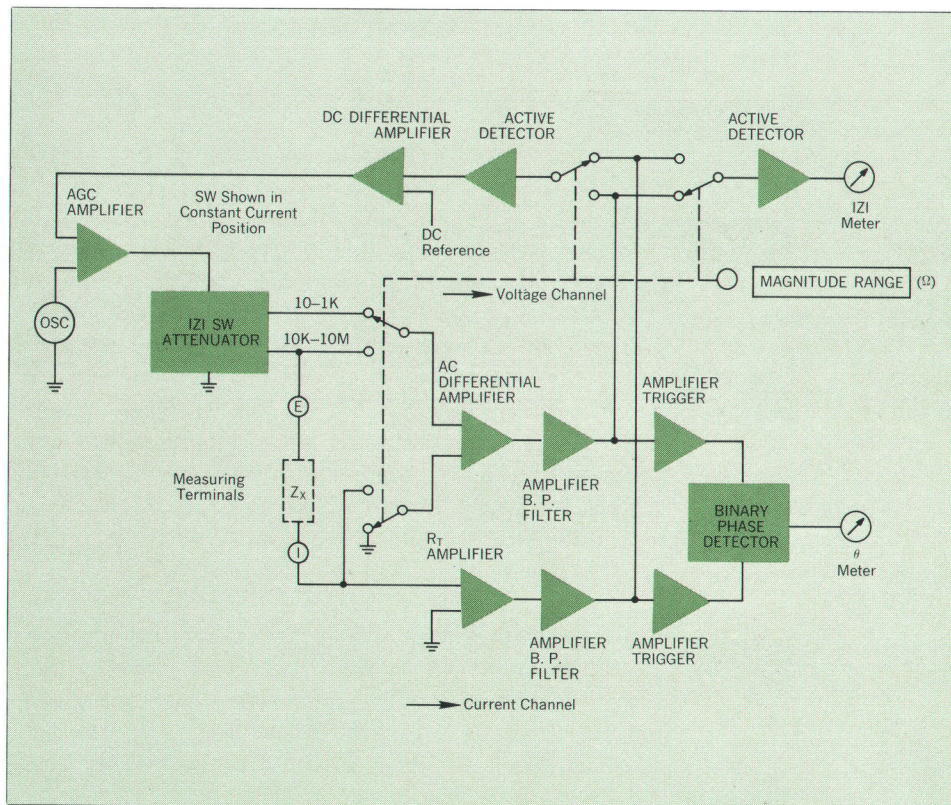

Fig. 2. In the *-hp-* Model 4800A, the unknown impedance is in the feedback loop of the trans-resistance (R_T) amplifier. The R_T amplifier is designed to be very broadband, critically damped with extremely critical phase-gain relationships so that unknowns with wide variations in phase angle and amplitude may be placed in the feedback loop without causing oscillation or instability in the amplifier.

and setting the range switch. Both instruments together cover the frequency range from 5 Hz to 108 MHz, but their applications differ somewhat.

5 Hz to 500 kHz Vector Impedance Meter

The lower frequency instrument, the *-hp-* Model 4800A Vector Impedance Meter, Fig. 1, provides continuous coverage from 5 Hz to 500 kHz in five bands and measures impedance from 1 ohm to 10 megohms in seven ranges. It is designed for making passive measurements of components attached to its front-panel terminals.

Impedances in the 1-ohm to 1000-ohm range are measured by passing a predetermined current through the unknown and measuring the voltage across it. For impedances between 1000 ohms and 10 megohms, a predetermined voltage is put across the unknown and

the current is measured and read out in ohms on the front panel meter.

Phase angle information is obtained by comparing the relative phase between the voltage and current by means of a phase detector. The basic elements of the instrument are shown in Fig. 2.

Constant-current mode. In the low impedance ranges of the *-hp-* Model 4800A, the current is held constant across the unknown by means of an automatic level control (ALC), Fig. 3(a). The current sensor is a trans-resistance (R_T) amplifier which accepts the input current and supplies an output voltage equal to the input current times the effective transresistance. This voltage (proportional to the current in the unknown) is used to reference the AGC amplifier signal level which, in turn, feeds a leveled signal to the current-determining resistor.

The voltage across the unknown is applied to a differential amplifier, then fed to an averaging detector. Output from the detector is read out in ohms on the impedance magnitude meter.

Constant-voltage mode. Above 1,000 ohms it is difficult to maintain a constant current for a decade change in impedance. Therefore a constant voltage is maintained across the unknown, Fig. 3(b).

COVER

Measuring impedance at a point in a circuit using the probe terminal of a new direct-reading RF vector impedance meter. Rapid measurements over a broad frequency range can be made without tedious manipulation or point-by-point plotting.

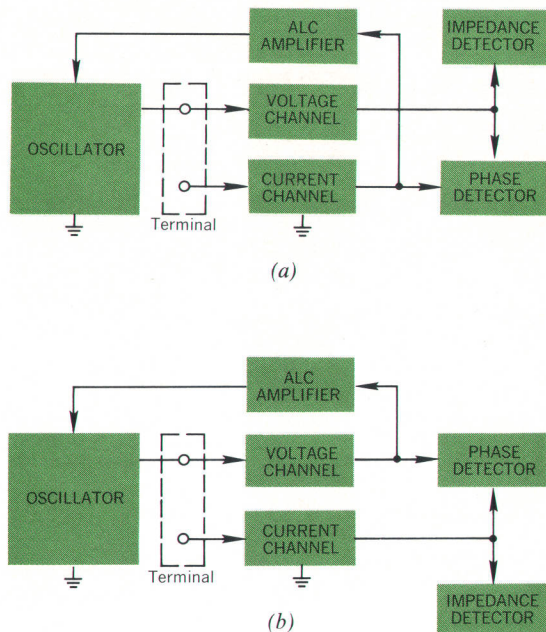

Fig. 3. The low-frequency impedance meter is operated so that current through the unknown is held constant for impedances less than 1,000 ohms (a). Since it is difficult to hold current constant at higher impedances, the instrument is switched to the constant voltage mode (b).

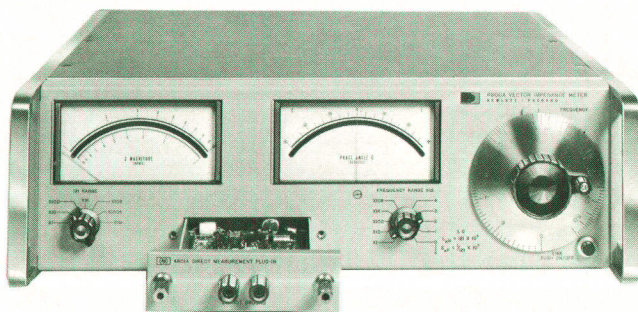

Fig. 4. Current and voltage channels and switching functions are contained in a plug-in which also contains the measurement terminals.

The AGC amplifier signal is fed to the attenuator which puts the known voltage across the unknown. The voltage is sensed and fed back to the AGC amplifier as in the constant-current mode. The current in the unknown is converted to a proportional voltage, amplified and read out on the impedance magnitude meter.

Measurement Amplifier Plug-in. The voltage and current sensors and switching functions necessary to provide operating signals to the current and voltage channels are contained in a front-panel plug-in (Fig. 4). The current sensor is the R_T amplifier mentioned previously. The voltage sensor is a differential amplifier which monitors the voltage across the unknown without loading the measurement terminals. Current and voltage channels in the plug-in are separated by a shield. This plug-in concept permits flexibility in future design. With the present plug-in, neither terminal may be grounded.

Phase Measurement. Phase angle is measured in the same manner in both the voltage and current modes. Signals from the voltage and current channels are compared to obtain the phase angle. The signal from the voltage channel goes to a zero crossing detector whose output turns on one half of a bistable multivibrator when the voltage signal passes through zero in a positive direction.

The current signal goes to an identical zero crossing detector whose output is used to turn off the same half of the multivibrator that the voltage channel turned on. The time that the flip-flop is on is proportional to the phase difference, and thus its output voltage is proportional to the phase difference between the voltage and current. A zero-center phase meter calibrated in degrees reads this voltage as phase angle.

High Frequency Vector Impedance Meter

Designed to use a probe terminal arrangement, a higher frequency instrument, the *hp*- Model 4815A RF Vector Impedance Meter, Fig. 5, covers the frequency range from 500 kHz to 108 MHz. It is designed to measure the magnitude and phase angle of the driving point impedance placed across its probe tip to ground. This makes direct-reading in-circuit measurements possible, and the instrument is also designed to measure impedance of active circuits including those having negative real components.

Basically, the block diagram of the RF Vector Impedance Meter resembles that of the lower frequency *hp*- Model 4800A with four notable exceptions—a phase lock loop, samplers, probe and grounded measurement capability, Fig. 6. In addition the instrument operates only in the constant-current mode.

Design Philosophy of Vector Impedance Meters

The operation of both vector impedance meters is based directly upon the fundamental definition of impedance

$$Z/\theta = \frac{|E|/\theta_1}{|I|/\theta_2} = \frac{|E|}{|I|} / \theta_1 - \theta_2$$

In the simplified block diagram of a typical vector impedance meter, a broadband oscillator applies a CW signal to an amplifier whose output may be leveled. The AC signal from the amplifier passes through the unknown impedance mounted across terminals A and B. Current flows from the B terminal through the ammeter to ground. Thus, the current through the unknown is sensed by the ammeter and used to generate an AGC signal which levels the output of the amplifier. The purpose of the AGC loop is to hold the current constant through the unknown. Since $Z = E/I$, and I is a constant, Z is directly proportional to the voltage across the unknown. A high-impedance broadband voltmeter across terminals A and B can be calibrated to read impedance directly.

To determine the phase angle between the voltage and current, the AC outputs from the voltmeter and ammeter

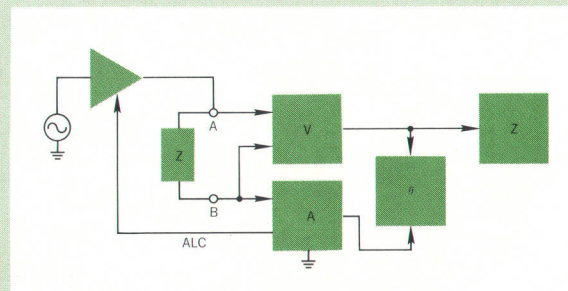

are fed to a phase detector which is calibrated directly in phase angle.

From the preceding discussion, it is obvious that it is immaterial whether voltage is held constant or whether current is held constant, so long as one of the two parameters is held constant. Also the voltmeter, ammeter and phase meter portions of the circuit may either be broadband, or may be track-tuned to the excitation oscillator frequency. Third, the connection to the ammeter at terminal B may be either a direct connection or inductively coupled.

Probe. Because operating frequencies of the *-hp-* Model 4815A are high, the current can be monitored with a toroid current transformer in a probe. In addition to the toroid current transformer, the probe contains both the voltage and current channel samplers, a coaxial delay line and the RF test signal injection lead which feeds through the center of the toroid to the probe tip, and is actually the current transformer primary.

The voltage appearing across the unknown is taken from the probe tip through the delay line to the voltage sampler. The current measurement is taken from the secondary of the toroid current transformer.

Voltage and current are sampled at different instants in real time to avoid crosstalk in the measuring channels. The delay line in the voltage channel compensates for the phase difference due to the sampling time difference, thus preserving phase information.

Samplers. Synchronous sampling techniques are used to convert the RF to constant IF frequency signals in the probe. Sampler theory and sampler characteristics have been discussed in previous articles.^{1,2} In this instrument, the samplers used for both channels are identical. The IF is 5 kHz with sampling rate controlled with a phase

lock loop. By phase comparison of the IF to a reference, a voltage is derived that controls the frequency of a voltage-tuned oscillator in the phase lock loop. Fast pulses for operation of the samplers are produced by a sampler pulse generator synchronized with the voltage-tuned oscillator.

IF System. Two high-gain, narrow band 5 kHz channels, one voltage and one current, terminate in average detectors. In the *-hp-* Model 4815A, the current channel

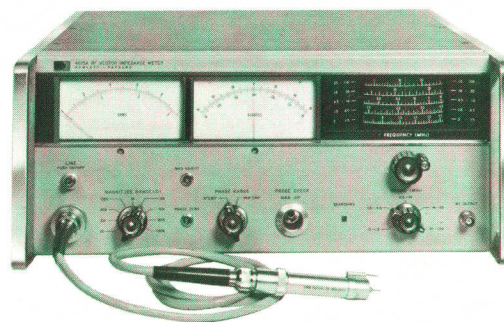

Fig. 5. In-circuit measurements of both active and passive devices and circuits can be made and read out directly over a frequency range of 500 kHz to 108 MHz with the new *-hp-* Model 4815A RF Vector Impedance Meter.

¹ Gerry Alonzo, 'Considerations in the Design of Sampling-Based Phase-Lock Loops,' WESCON 1966, Technical Papers 23/2.

² Fritz K. Weinert, 'The RF Vector Voltmeter,' *Hewlett-Packard Journal*, Vol. 17, No. 9, May 1966, p. 2.

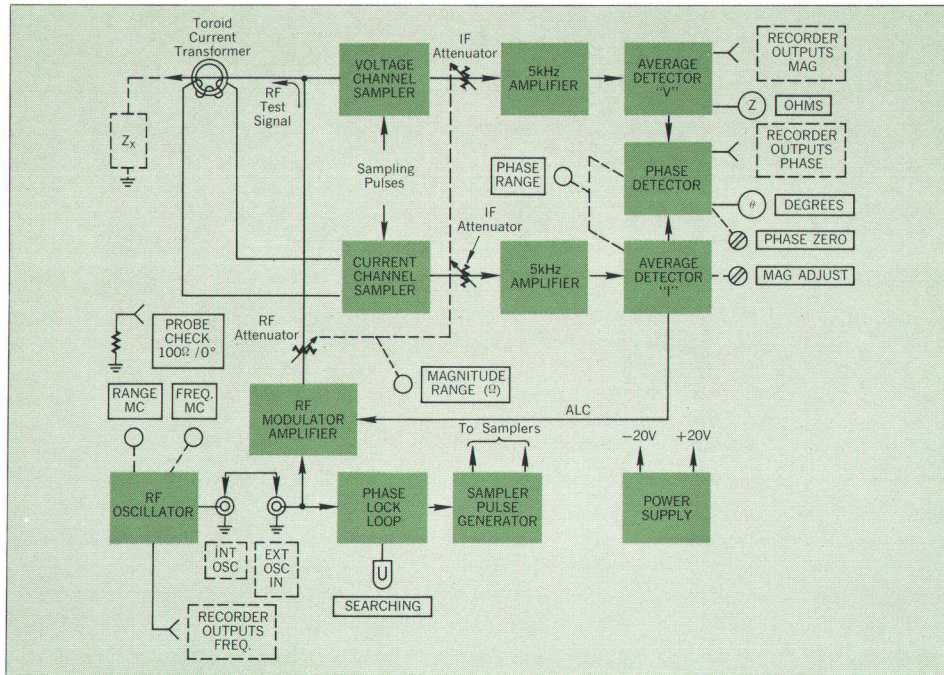

Fig. 6. Both vector impedance meters use the same basic logical arrangement, but the high frequency meter uses synchronous sampling techniques which provide tracked tuning of voltage and current channels to produce the 5 kHz IF frequency.

5 kHz signal is amplified, detected and applied to a modulator to form a closed-loop automatic level control (ALC) that holds the test signal current constant.

By holding the RF test signal current constant, the voltage across the unknown is proportional to impedance magnitude. The 5 kHz voltage channel IF is amplified and detected in a manner similar to the current channel. The detected output is read out on the front-panel meter as 'ohms.' The single-frequency IF system makes possible very high Q measurements.

Signals from both the voltage and current channels are limited to remove amplitude variations. They are then applied to a binary phase detector whose output is read on the front-panel phase meter.

Applications of Vector Impedance Meters

Both vector impedance meters can make a wide variety of measurements. Many components can be measured using either instrument. However due to the difference in frequency coverage and circuit configuration, certain measurements must be performed with the instrument designed for that purpose.

The high-frequency RF Vector Impedance Meter with its probe for in-circuit measurements can be used for measurement of both active and passive devices and circuits. The low frequency Model 4800A is generally limited to measurements of passive components, but with blocking capacitors, may be used to make measurements in circuits with dc present. It can measure active circuits so long as the phase angle is 90° or less and the power supply for the circuit is isolated from the instrument.

Inductance and Capacitance

Both instruments can be used to determine inductance or capacitance of discrete components. Components may be attached directly to the front panel terminals of the -hp- Model 4800A, or to the component mounting adapter attached to the probe of the -hp- Model 4815A, Fig. 7. Impedance is measured directly in terms of polar coordinates Z and phase angle θ . Using simple trigonometric relationships, the polar coordinates can be converted into rectangular form where the horizontal component of Z is resistance and the vertical component is inductive or capacitive reactance.

Measuring Q

Low Q components. For a low Q component, that is less than 10, simply determine the phase angle and refer to a table of tangents, since:

$$\tan \theta = \frac{X_L}{R} = Q$$

High Q components. By adding the necessary resonating element, the Δf method may be used to calculate Qs greater than 10. For either parallel or series resonance:

$$Q = f_0 / \Delta f$$

where f_0 is the resonant frequency and Δf is the bandwidth. f_0 is the frequency where $\angle Z$ is zero degrees. The bandwidth Δf is the numerical difference between the frequency above resonance (f_2) where $\angle Z$ is - or +45°, and the frequency below resonance (f_1) where $\angle Z$ is + or -45°.

When calculating the Q of small inductors the effect of

stray inductance L_s in series with the resonating capacitance, Fig. 8, is included by altering the Δf equation to

$$Q \approx (f_0/\Delta f) [1/(1 + L_s/L)].$$

Another method, called frequency ranging compares the impedance of the circuit at resonance to its impedance when it is not at resonance. If $|Z|_1$ is the impedance of the circuit at resonance (f_0) and $|Z|_2$ is the impedance of the circuit at $0.1 f_0$ or $10 f_0$ then

$$Q \approx \frac{|Z|_1}{10|Z|_2} \text{ for parallel resonance, and}$$

$$Q \approx \frac{|Z|_2}{10|Z|_1} \text{ for series resonance.}$$

This method will not work for crystals, resonant lines and similar devices.

High Q circuits. The Q of high Q circuits, that is greater than 10, can be calculated by either the Δf or the frequency ranging methods.

Low Q circuits. When circuit Q is less than 10, the Q is still accurately calculated by the Δf method provided that the loss is in shunt in a parallel resonant circuit or in series in a series resonant circuit. In parallel resonant circuits where the loss can be assumed primarily in series with the inductor, Fig. 8, a modified form of the Δf method calculates Q accurate to ± 0.5 for all Q with the formula:

$$Q = \frac{f_0}{2(f_2 - f_0)} - 0.5$$

where f_0 is the frequency at 0° phase angle and f_2 is the frequency at -45° phase angle. The Q calculated is for frequency f_0 .

Crystal Resonance

A crystal may be represented by the equivalent circuit, Fig. 9(a). This circuit exhibits a series and parallel resonance very close together in frequency, Fig. 9(b), with the series resonance occurring at the lower of the two frequencies.

Crystal resonance may be easily measured with the -hp- 4815 RF Vector Impedance Meter. Series resistance R_s may be read directly by tuning to series resonance and reading impedance directly. For more accurate frequency measurements, an electronic counter may be driven from the front panel RF output terminal.

From a plot of impedance versus frequency, it is possible to determine the capacitive reactance needed to pull the crystal frequency to some desired value. It also is possible to calculate the sensitivity of the pulled frequency to changes in the pulling capacitance. Besides crystal capacitance and inductance, Q may also be determined.

Since crystal Q may be very high (up to 2 million for natural quartz), it is generally desirable to use a counter for frequency measurement. For Q greater than 100,000, a high-accuracy, high-resolution frequency source such as a frequency synthesizer is desirable.



Fig. 7. Discrete components may be measured at high frequencies by clipping them to the component mounting adapter of the -hp- Model 4815A. This toroid is being checked at a frequency below resonance.

Fig. 8. All losses associated with a Q measuring circuit should be considered when measuring Q of a small inductor. The stray inductance L_s of the resonating capacitor C and the resistive losses R of the inductor L are shown.

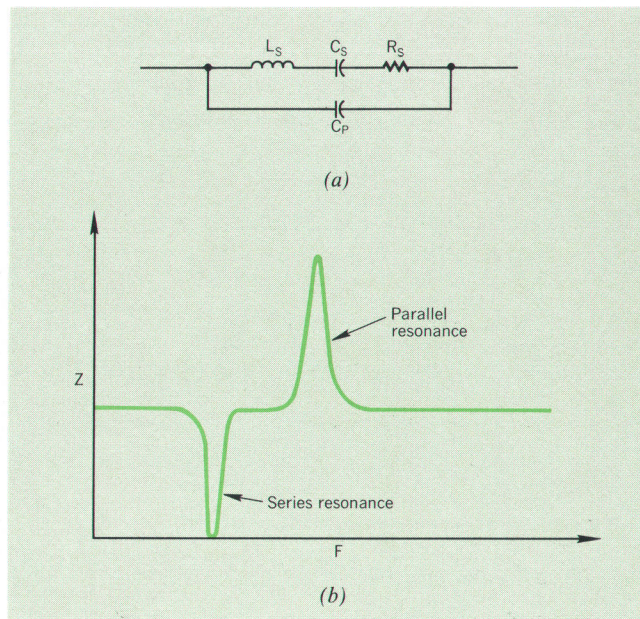
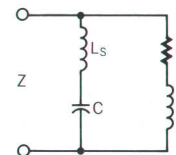

Fig. 9. Each resonance of a crystal may be represented with the equivalent circuit (a). All crystals exhibit a low impedance series resonance and a high impedance parallel resonance (b), very close together in frequency, with the series resonance at the lower of the two frequencies.

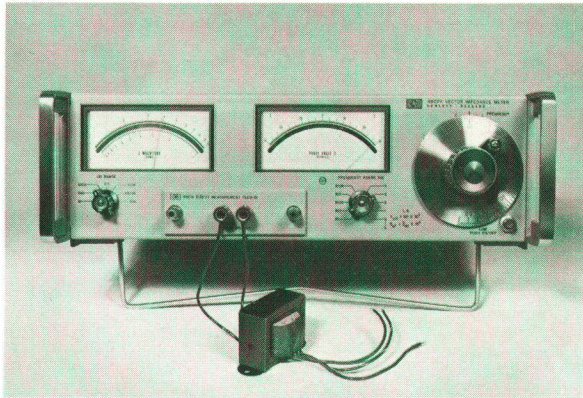

Fig. 10. A number of transformer parameters may be determined with both vector impedance meters. An iron-core transformer used at lower frequencies may be quickly characterized using the -hp- Model 4800A.

Transformer Measurements

One of the more sophisticated capabilities of the vector impedance meters is characterizing a transformer, Fig. 10. With the transformer secondary open and the primary connected to the terminals of the instrument, the primary inductance can be measured directly by choosing a frequency range where the phase is between plus 85° and 90° . The copper and core losses in the primary vary with frequency and can be determined at the lowest measurement frequency where the phase angle is 45° , since the inductive reactance is equal to the resistance at this frequency. The resistance is then 0.707 times the impedance, as read on the Z magnitude meter.

Transformer capacitance. Capacitance of the transformer primary can be determined by selecting a measurement frequency at which the primary inductance and capacitance resonate (phase angle of 0°). If this frequency is out of the range of the instrument, an external capacitor of known value can be shunted across the primary. Since the inductance and the frequency are known, the transformer capacitance is the resonating capacitance minus the known shunt capacitance.

Primary-to-secondary capacitance of the transformer can be measured by using one lead each of the primary and secondary as terminals. With the frequency dial set to an appropriate frequency, the capacitance can be read directly. The effectiveness of interwinding shields can be measured by connecting shields to the ground terminal of the -hp- Model 4800A.

Turns Ratio. To find turns ratio, the equations $Z_s = n^2 Z_p$ and $n^2 = Z_s / Z_p$ are used, where n equals the number of secondary turns divided by the number of primary turns. Then, by selecting a frequency where the primary inductance is high with respect to some resistance, say 100 ohms, a 100-ohm resistor placed across the secondary will reflect an impedance in the primary. Using the equations, $Z_s = 100$ ohms and Z_p is the reading on the Z magnitude meter. A near zero phase angle reading assures that the Z magnitude meter is reading a reflected resistance and not an inductance in the transformer itself.

Mutual inductance. It is possible to determine mutual inductance of the transformer by measuring its inductance in a series aiding configuration and then in a series opposing configuration. Subtracting the smaller reading

SPECIFICATIONS

-hp- MODEL 4800A VECTOR IMPEDANCE METER

Frequency Characteristics

Range: 5 Hz to 500 kHz in five bands: 5 to 50 Hz, 50 to 500 Hz, 0.5 to 5 kHz, 5 to 50 kHz, 50 to 500 kHz.

Accuracy: $\pm 2\%$ from 50 Hz to 500 kHz, $\pm 4\%$ from 5 to 50 Hz, $\pm 1\%$ at 15.92 on frequency dial from 159.2 Hz to 159.2 kHz, $\pm 2\%$ at 15.92 Hz.

Monitor output: level: 0.2 volt rms minimum; source impedance: 600 ohms nominal.

Impedance Measurement Characteristics

Range: 1 ohm to 10 megohms in seven ranges: 10 ohms, 100 ohms, 1000 ohms, 10K ohms, 100K ohms, 1 megohm, 10 megohms full scale.

Accuracy: $\pm 5\%$ of reading.

Phase Angle Measurement Characteristics

Range: $0^\circ \pm 90^\circ$.

Accuracy: $\pm 6^\circ$.

Calibration: increments of 5° .

Direct Inductance Measurement Capabilities

Range: 1 μ H to 100,000H, direct reading at decade multiples of 15.92 Hz.

Accuracy: $\pm 7\%$ of reading for Q greater than 10 from 159.2 Hz to 159.2 kHz; $\pm 8\%$ of reading for Q greater than 10 at 15.92 Hz.

Direct Capacitance Measurement Capabilities

Range: 0.1 pF to 10,000 μ F, direct reading at decade multiples of 15.92 Hz.

Accuracy: $\pm 7\%$ of reading for D less than 0.1 159.2 Hz to 159.2 kHz, $\pm 8\%$ of reading for D less than 0.1 at 15.92 Hz.

Measuring Terminal Signal Characteristics

Wave shape: sinusoidal.

Distortion: less than 1% from 10 Hz to 50 kHz, less than 0.3% from 50 Hz to 500 kHz, less than 1.5% from 5 Hz to 10 Hz.

Signal level: less than 2.7 mV rms 1 to 1000 ohms, approximately 27 mV rms 10K to 100K ohms, approximately 270 mV rms 100K ohms to 1 megohm, approximately 2.7 V rms 1 megohm to 10 megohms.

Weight: net 24 lbs. (10.8 kg), shipping 30 lbs. (13.5 kg).

Power: 105 to 125 V or 210 to 250 V, 50 to 400 Hz.

Price: \$1,490; Option 01, recorder outputs for Z, θ , and frequency \$100.

-hp-

MODEL 4815A RF VECTOR IMPEDANCE METER

Frequency

Range: 500 kHz to 108 MHz in five bands: 500 kHz to 1.5 MHz, 1.5 to 4.5 MHz, 4.5 to 14 MHz, 14 to 35 MHz, 35 to 108 MHz.

Accuracy: $\pm 2\%$ of reading, $\pm 1\%$ of reading at 1.592 and 15.92 MHz.

RF monitor output: 100 mV minimum into 50 ohms.

Impedance Magnitude Measurement

Range: 1 ohm to 100K ohms; full-scale ranges: 10, 30, 100, 300, 1K, 3K, 10K, 30K, 100K ohms.

Accuracy: $\pm 4\%$ of full scale $\pm \left(\frac{f}{30 \text{ MHz}} + \frac{Z}{25 \text{ K}\Omega} \right) \%$ of reading, where f = frequency in MHz and Z is in ohms; reading includes probe residual impedance.

Calibration: linear meter scale with increments 2% of full scale.

Phase Angle Measurement

Range: 0 to 360° in two ranges: $0 \pm 90^\circ$, $180^\circ \pm 90^\circ$.

Accuracy: $\pm \left(3 + \frac{f}{30 \text{ MHz}} + \frac{Z}{50 \text{ K}\Omega} \right)$ degrees; where f = frequency in MHz and Z is in ohms.

Calibration: increments of 2° .

Weight: net 39 lbs. (17.6 kg), shipping 50 lbs. (22.5 kg).

Power: 105 to 125 V or 210 to 250 V, 50 to 400 Hz.

Price: \$2650.

Manufacturing Division:

-hp- Rockaway Division
Green Pond Road
Rockaway, New Jersey 07866

Prices f.o.b. factory

Data subject to change without notice

from the larger reading and dividing the result by four yields mutual inductance.

Leakage inductance. To determine leakage inductance of a transformer, the secondary is shorted and the shorting inductance read on the Z magnitude meter. If the leakage reactance is too small to be read directly, a capacitor which will resonate with the leakage inductance may be connected across the primary. The leakage inductance can then be calculated from the known frequency and capacitance.

Semiconductor Measurements

Dynamic Impedance of Diodes. Both instruments may be used to determine the dynamic impedance of diodes using a known dc current source. (Use blocking capacitors with the low-frequency -hp- Model 4800A.) The impedance of the diode can then be recorded as a function of current. Similarly, by back biasing the diode, the junction capacitance vs. voltage can be measured. Obviously, voltage variable capacitors and current variable inductors can be measured and recorded as a function of voltage and current respectively. Care must be taken to insure that the test signal level does not bias the diodes.

Transistor Measurements. Using a slightly more complicated biasing system than that used for diodes, the input impedance of a transistor can be measured. With the base of the transistor connected to one terminal of the -hp- Model 4800A, and the emitter connected to the other, and the collector connected to the base through a capacitor, Fig. 11(a), the instrument will measure h_{ib} . With the base connected to one terminal, the emitter connected to the other, and the collector connected to the emitter through a capacitor, Fig. 11(b), the instrument will measure h_{ie} . If the same biasing currents and voltages are used for both the h_{ib} and h_{ie} measurements, then from the equation

$$h_{ib} \approx \frac{h_{ie}}{1 + h_{fe}}$$

or h_{fe} can be determined using the relationship:

$$h_{fe} \approx \frac{h_{ie}}{h_{ib}} - 1$$

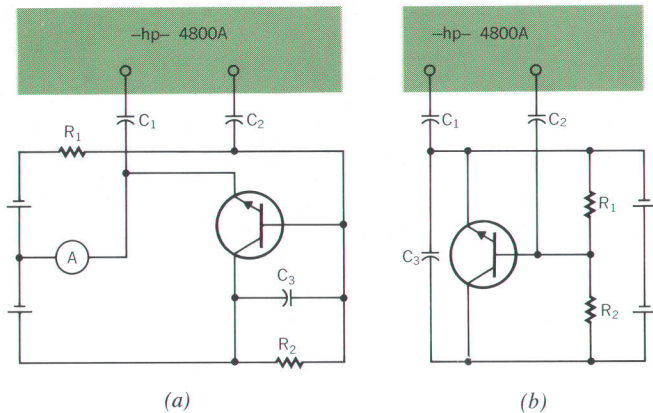

Fig. 11. Using an appropriate biasing scheme (a) it is possible to measure h_{ib} (small signal input impedance) of a transistor. By reconnecting the circuit (b) the instrument will measure h_{ie} . C_1 and C_2 are dc blocking capacitors, and R_1 and R_2 are bias resistors.

Collector-to-base capacitance can also be measured by connecting the collector to one terminal and the base to the other.

In using the -hp- Model 4815A RF Vector Impedance Meter for measuring high-frequency devices, care must be taken to avoid oscillation.

Measuring Active Circuits

Negative impedances. With the -hp- Model 4815A RF Vector Impedance Meter it is possible to measure impedances with negative real parts. The phase angle of these impedances is indicated on the $180^\circ \pm 90^\circ$ range of the meter. Negative impedances are often present in feedback amplifiers with small phase margins.

Negative impedances are also present at all points in an oscillator loop. The -hp- Model 4815A RF Vector Impedance Meter can be used to quickly acquire data to plot negative impedance of an oscillator versus frequency of the test signal.

With the oscillator set to a fixed frequency, the impedance meter is run from a frequency above or below the fixed frequency, through the oscillator frequency and beyond. At the frequency of oscillation, the phase angle will be about 180° . To make the measurement it is necessary that application of the -hp- Model 4815A probe stop the oscillation. Oscillation will usually be squelched if the magnitude of the effective shunt negative resistance is larger than 50 ohms.

The slope of the phase angle versus frequency gives an indication of oscillator stability. If the phase slope is small the oscillator is less stable. The reading of the magnitude of negative resistance at the frequency of oscillation is related to the amount of positive feedback.

HEWLETT-PACKARD JOURNAL

TECHNICAL INFORMATION FROM THE
LABORATORIES OF THE HEWLETT-PACKARD COMPANY

hp JANUARY 1967 Volume 18 • Number 5

PUBLISHED AT THE CORPORATE OFFICES
1501 PAGE MILL ROAD, PALO ALTO, CALIFORNIA 94304

Staff: F. J. BURKHARD, Editor; R. P. DOLAN, L. D. SHERGALIS
R. A. ERICKSON, Art Director

Mixer input and output impedance. With special care, with the use of the *-hp-* Model 4815A only, it is possible to measure the input and output impedance of a mixer while it is being excited with the local oscillator. The special care required is to insure that the measurement be made at frequencies such that the impedance meter test signal does not mix with that of the local oscillator to produce an error signal.

The proper frequencies are generally too difficult to calculate in advance, but can be determined easily while making the measurement. When an interfering signal is producing an error, the measured impedance indicated on the meter will experience wild variations for small changes in frequency. Between any two successive frequencies at which an error signal is found, there should be a range for which the measured impedance is essentially constant. The impedance within this range is the true value.

If the signal in the circuit is modulated, especially if it is frequency or phase modulated, the chance of mixing is greatly increased. In fact, it may not be possible to find a point where interference does not occur, thus the measurement may not be possible at all.

Loop Gain. The *-hp-* Model 4815A can also be used to measure the magnitude and phase angle of loop gain of high frequency feedback amplifiers. The loop gain is found by measuring impedances at a single point internal to the loop under two conditions. One condition is with the loop closed (Z_{CL}) and the second condition is with the loop opened (Z_{OL}). When the loop is opened care must be taken not to disturb the impedance at the point being measured. The loop gain is then equal to

$$\text{loop gain} = 1 - \frac{\text{open loop impedance}}{\text{closed loop impedance}}$$

Other Applications

Both instruments have the capability of many additional applications involving components. For example, the length and electrical properties of transmission lines, distributed capacitance of measuring instruments and variations in the frequency response of toroidal transformers with changes in core material may be obtained.

With careful measurement techniques, it is possible to obtain useful data on passive components in which interfering signals may be present. Transducers, loudspeakers and mixers are characteristic of this class of measurement.

Acknowledgments

Many persons contributed to the design and development of the two vector impedance meters. On the *-hp-* Model 4800A, the authors wish to acknowledge the contributions of Donald A. Gann for his work on the auto-leveling control loop, John D. Swank who designed the plug-in and phase circuitry, Richard N. Shulte who did

the product design, Robert J. Thorn for the printed-circuit layouts and Lawrence O. Cook who made the precision components. Steve Vitkovitz, engineering manager of the Rockaway Division, made valuable contributions to the project.

On the *-hp-* Model 4815A, Robert W. Colpitts worked on the electronic design, and Joseph Dykhuizen and Norman W. Bowers handled the mechanical design. They were assisted by Robert D. Schweizer. Valuable contributions were made by Tor Larson, Johann Blokker and Paul Stoft, director of the electronics research laboratory of the *-hp-* Laboratories.

—Gerald J. Alonzo,
Richard H. Blackwell and
Hirsh V. Marantz

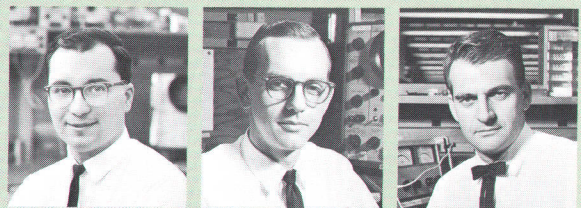

Gerald J.
Alonzo

Richard H.
Blackwell

Hirsh V.
Marantz

Gerry Alonzo started with Hewlett-Packard in 1957 in the engineering pool, then worked part time in Advanced Research and Development from 1960 to 1963. During that time he attended Stanford University and received his BS in EE in 1961, his MS in EE in 1962 and the degree of Engineer in EE in 1963.

After joining Hewlett-Packard full time in 1963, Gerry worked as a circuit design engineer on the *-hp-* Model 8405A Vector Voltmeter. In 1964 he became project leader on the *-hp-* Model 4815 RF Vector Impedance Meter and in June 1966 assumed the duties of project leader on Medical Ultrasonics at the Hewlett-Packard Laboratories.

Dick Blackwell joined the *-hp-* Rockaway Division after graduating from North Carolina State University in 1962. He was project leader and worked on the circuit design of the *-hp-* Model 207H Univerter. After two years with the U. S. Army Security Agency, he returned to Hewlett-Packard and worked on the *-hp-* Model 4815A project in Palo Alto. He became project leader when the project was transferred to the Rockaway Division early in 1966. Dick is a member of Eta Kappa Nu and IEEE.

Hirsh Marantz is a graduate of Fairleigh Dickinson University, 1959, with the degree of BSEE. After graduation he spent several years in circuit design and was a project leader on a solid state receiver project. He joined the *-hp-* Rockaway Division in 1963 where he has worked on the *-hp-* Model 202H FM Signal Generator.

Hirsh is presently project leader on the *-hp-* Model 4800A Vector Impedance Meter. He is a member of IEEE.